

Step On / Drive On Recessed Aluminium Profile

- 5 Year Warranty
- Endcaps & mounting clips included
- 2000mm length
- Can be cut to size
- Suitable for recessed
- Opal light diffuser
- Excellent heat sink
- Anodized aluminium
- * Powdercoating available

JB2911-2M

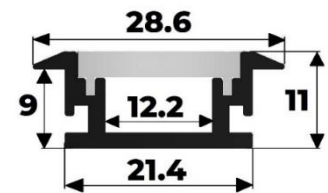
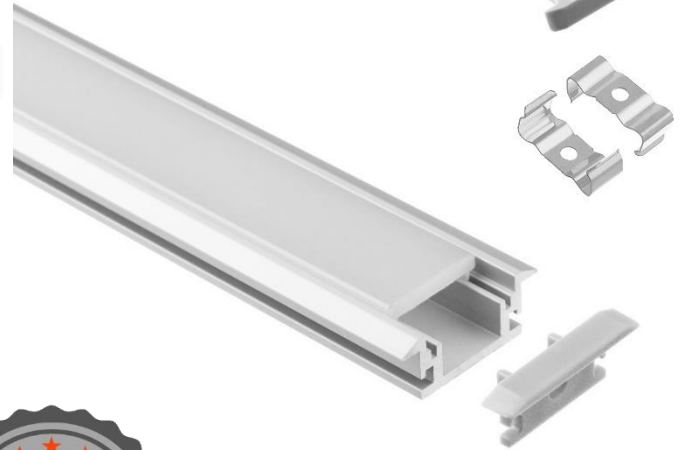

Call us now on (03) 8521-6470
to quote your project big or small



Installation

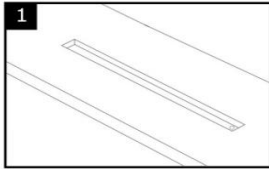

1 Create a recess for profile, ensure that a second recess is also created for the driver.

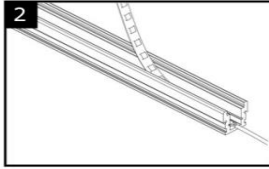

2 Remove the adhesive tape on the back of the LED strip tape. Position LED strip carefully and stick down.

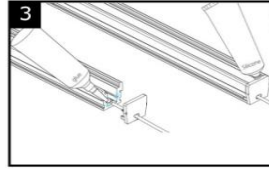

3 Feed endcaps onto profile and silicone to secure and waterproof profile.

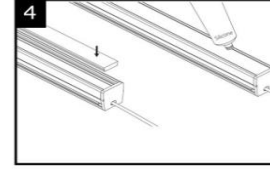

4 Push diffuser into aluminium and use silicone to waterproof.

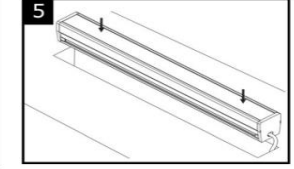

5 Press the profile into the recess ensuring the driver wire has been threaded through the second recess.

Key Information

- ❖ Face 28.6mm
- ❖ Dimensions 2000mm x 28.6mm x 11mm
- ❖ Material Premium quality extruded anodized aluminium
Premium quality frosted light diffuser
- ❖ LED Strip Suits all JB-SL12V & JB-SL24V Strip Light Range
Compatible with 8mm, 10mm & 12mm width LED strip light

Specification subject to change without prior notice. Last updated 01/08/2021